

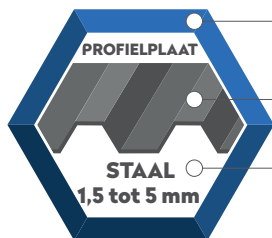

# ZELFBORENDE SCHROEF BP3

## TOEPASSING



Verzinkt

Profielplaatbevestiger

Staal 1,5 tot 5 mm

## SPECIFICATIE

- 1 Aansluiting 5/16" (8 mm)
- 2 Ringdiameter standaard 16 mm
- 3 Verzinkt met aangevulcaniseerd EPDM
- 4 Draad t.b.v. ondergrond staal 1,5 tot 5 mm
- 5 Boorpunt 3

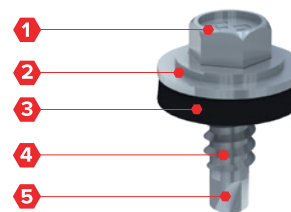

## OPTIES

- 1 Poedercoat in iedere gewenste RAL kleur
- 2 Ringdiameter 19 of 22 mm

## DOORSNEDE

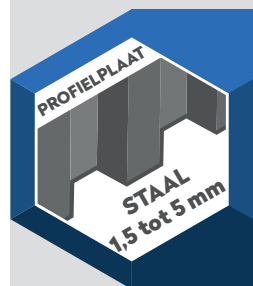
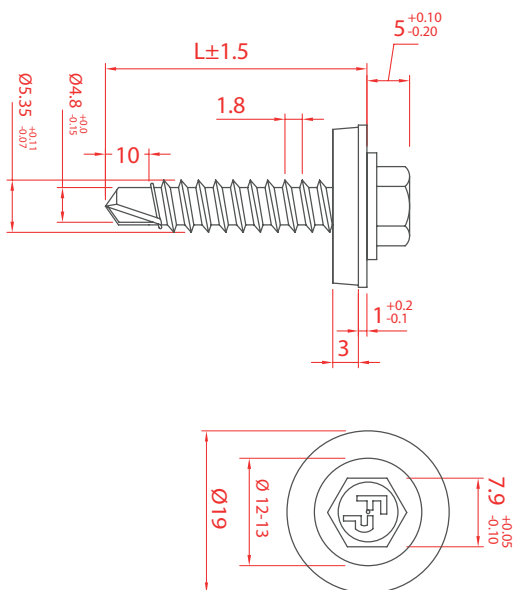

PROFIELPLATEN - STAAL 1,5 TOT 5 MM - VERZINKT

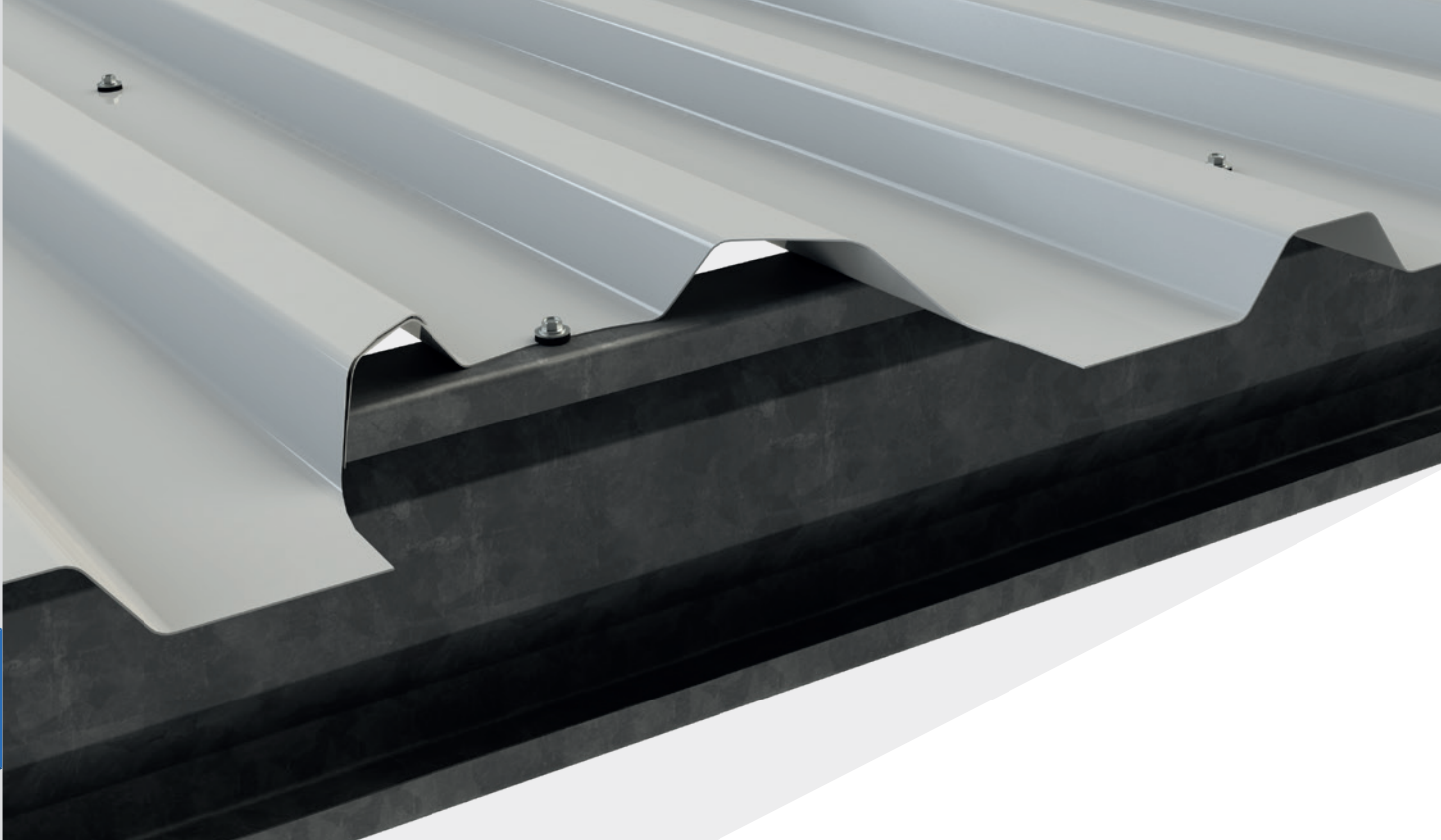
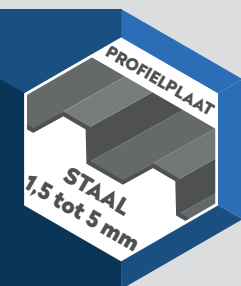

**PROFIELPLATEN - STAAL 1,5 TOT 5 MM - VERZINKT**

## BESTELINFORMATIE

Product	Afmeting (L)	Verpakking	Artikelcode
Zelfborende schroef 5,5 x 25 - BP3	25 mm	250 st/doos	2004035502516
Zelfborende schroef 5,5 x 38 - BP3	38 mm	250 st/doos	2004035503816



Meer informatie over de materiaalkeuze, toepassing, specifieke eigenschappen en certificeringen kunt u vinden in hoofdstuk 10.



# ZELFBORENDE SCHROEF BP3

## HET JUISTE AANTAL SCHROEVEN

Buitenplaat dikte	Oplegging	Overspanning	Aan de kust						In het binnenland					
			Aantal velden						Aantal velden					
			1			≥ 2			1			≥ 2		
			Ø16 mm	Ø19 mm	Ø22 mm	Ø16 mm	Ø19 mm	Ø22 mm	Ø16 mm	Ø19 mm	Ø22 mm	Ø16 mm	Ø19 mm	Ø22 mm
0,4	eind	2000	2	2	2	2	1	1	1	1	1	1	1	1
		3000	3	2	2	2	2	2	2	2	1	1	1	1
		4000	3	3	3	3	2	2	2	2	2	2	2	1
	tussen	2000	-	-	-	4	4	3	-	-	-	2	2	2
		3000	-	-	-	6	5	5	-	-	-	3	3	3
		4000	-	-	-	7	7	6	-	-	-	4	4	4
0,5	eind	2000	2	1	1	1	1	1	1	1	1	1	1	1
		3000	2	2	2	2	1	1	1	1	1	1	1	1
		4000	3	2	2	2	2	2	2	1	1	1	1	1
	tussen	2000	-	-	-	3	3	3	-	-	-	2	2	2
		3000	-	-	-	5	4	4	-	-	-	3	2	2
		4000	-	-	-	6	5	5	-	-	-	4	3	3
0,63	eind	2000	2	1	1	1	1	1	1	1	1	1	1	1
		3000	2	2	2	2	1	1	1	1	1	1	1	1
		4000	3	2	2	2	2	2	2	1	1	1	1	1
	tussen	2000	-	-	-	3	2	2	-	-	-	2	2	1
		3000	-	-	-	4	3	3	-	-	-	3	2	2
		4000	-	-	-	6	4	4	-	-	-	3	3	2

### Toelichting

Het aantal bevestigingsmiddelen per oplegging in bovenstaande tabel is gebaseerd op standaard situaties (zie eveneens onderstaande uitgangspunten) en dient enkel ter indicatie van het aantal benodigde bevestigingsmiddelen. Indien een projectspecifieke berekening gewenst is, kunt u contact opnemen met Fastener Point.

### Uitgangspunten

- Aantal benodigde bevestigingen per oplegging voor een plaat met breedte 1000 mm
- Windbelasting conform NEN-EN1991-1-4 Zone I, gebouwhoogte 9 meter, onbebouwd, gevolklasse CC1, dakhelling 15°
- Ondergrond staaldikte 6 mm

## CERTIFICATEN



KWALITEIT  
BEVESTIGD

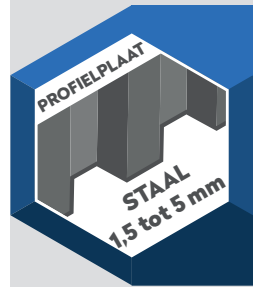



**ZELFBORENDE SCHROEF 5,5 X L - BP3, RINGDIAMETER Ø 16,0 MM**

Materialen	
Schroef	Verzinkt staal
Afdichtring	Verzinkt staal
Materiaal A ( $t_I$ )	S280GD, S320GD en S350GD conform EN 10346
Materiaal B ( $t_{II}$ )	S235 conform EN 10025-2, S280GD, S320GD en S350GD conform EN 10346
Boorcapaciteit	Staal $\leq$ 5 mm

KWALITEIT BEVESTIGD

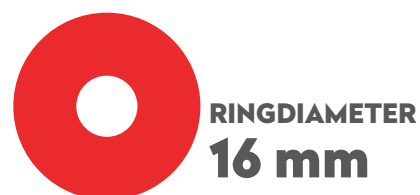
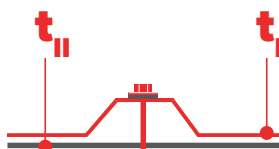
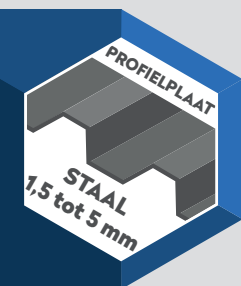



		$t_{NI}$ [mm]	$t_{II}$ [mm]					
			0,75	1,00	1,50	2,00	3,00	4,00
 $V_{R,k}$ [kN]	0,40	1,12	1,12	1,12	1,12	1,12	1,12	1,12
	0,50	1,61	1,61	1,61	1,61	1,61	1,61	1,61
	0,55	1,69	1,69	1,69	1,69	1,69	1,69	1,69
	0,63	1,81	1,81	1,81	1,81	1,81	1,81	1,81
	0,75	1,99	1,99	1,99	1,99	1,99	1,99	1,99
	0,88	1,99	3,17	3,17	3,17	3,17	3,17	3,17
	1,00	3,17	3,17	3,17	3,17	3,17	3,17	3,17
	1,13	3,17	3,17	3,17	3,17	3,17	3,17	3,17
	1,25	3,17	3,17	3,17	3,17	3,17	3,17	3,17
 $N_{R,k}$ [kN]	0,40	0,68	0,94	1,48	1,48	1,48	1,48	1,48
	0,50	0,68	0,94	1,78	1,78	1,78	1,78	1,78
	0,55	0,68	0,94	2,01	2,01	2,01	2,01	2,01
	0,63	0,68	0,94	2,06	2,39	2,39	2,39	2,39
	0,75	0,68	0,94	2,06	2,64	2,96	2,96	2,96
	0,88	0,68	0,94	2,06	2,64	2,96	2,96	2,96
	1,00	0,68	0,94	2,06	2,64	2,96	2,96	2,96
	1,13	0,68	0,94	2,06	2,64	2,96	2,96	2,96
	1,25	0,68	0,94	2,06	2,64	2,96	2,96	2,96

**Toelichting**



1. Bovenstaande waarden zijn karakteristieke waarden
2. Voor het bepalen van de rekenwaarde adviseren wij een materiaalfactor  $\gamma_m = 1,33$  te gebruiken
3. Verdere uitleg en rekenvoorbeelden treft u aan op pagina 10.1.7

**PROFIELPLATEN - STAAL 1,5 TOT 5 MM - VERZINKT**

**ZELBORENDE SCHROEF 5,5 X L - BP3, RINGDIAMETER Ø 19,0 MM**

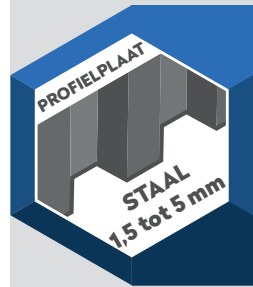
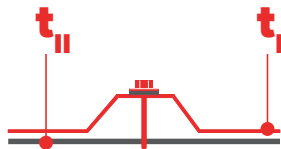
Materialen		  KWALITEIT BEVESTIGD
Schroef	Verzinkt staal	
Afdichtring	Verzinkt staal	
Materiaal A ( $t_{\perp}$ )	S280GD, S320GD en S350GD conform EN 10346	
Materiaal B ( $t_{\parallel}$ )	S235 conform EN 10025-2, S280GD, S320GD en S350GD conform EN 10346	
Boorcapaciteit	Staal $\leq$ 5 mm	



		$t_{\perp}$ [mm]	$t_{\parallel}$ [mm]						
			0,75	1,00	1,50	2,00	3,00	4,00	6,00
	$V_{R,k}$ [kN]	0,40	1,12	1,12	1,12	1,12	1,12	1,12	1,12
		0,50	1,61	1,61	1,61	1,61	1,61	1,61	1,61
		0,55	1,69	1,69	1,69	1,69	1,69	1,69	1,69
		0,63	1,81	1,81	1,81	1,81	1,81	1,81	1,81
		0,75	1,99	1,99	1,99	1,99	1,99	1,99	1,99
		0,88	1,99	3,17	3,17	3,17	3,17	3,17	3,17
		1,00	3,17	3,17	3,17	3,17	3,17	3,17	3,17
		1,13	3,17	3,17	3,17	3,17	3,17	3,17	3,17
		1,25	3,17	3,17	3,17	3,17	3,17	3,17	3,17
	$N_{R,k}$ [kN]	0,40	0,68	0,94	1,61	1,61	1,61	1,61	1,61
		0,50	0,68	0,94	2,06	2,37	2,37	2,37	2,37
		0,55	0,68	0,94	2,06	2,59	2,59	2,59	2,59
		0,63	0,68	0,94	2,06	2,64	2,93	2,93	2,93
		0,75	0,68	0,94	2,06	2,64	3,44	3,44	3,44
		0,88	0,68	0,94	2,06	2,64	3,44	3,44	3,44
		1,00	0,68	0,94	2,06	2,64	3,44	3,44	3,44
		1,13	0,68	0,94	2,06	2,64	3,44	3,44	3,44
		1,25	0,68	0,94	2,06	2,64	3,44	3,44	3,44

**Toelichting**

1. Bovenstaande waarden zijn karakteristieke waarden
2. Voor het bepalen van de rekenwaarde adviseren wij een materiaalfactor  $\gamma_m = 1,33$  te gebruiken
3. Verdere uitleg en rekenvoorbeelden treft u aan op pagina 10.1.7

**PROFIELPLATEN - STAAL 1,5 TOT 5 MM - VERZINKT**

**ZELFBORENDE SCHROEF 5,5 X L - BP3, RINGDIAMETER Ø 22,0 MM**

Materialen	
Schroef	Verzinkt staal
Afdichtring	Verzinkt staal
Materiaal A ( $t_I$ )	S280GD, S320GD en S350GD conform EN 10346
Materiaal B ( $t_{II}$ )	S235 conform EN 10025-2, S280GD, S320GD en S350GD conform EN 10346
Boorcapaciteit	Staal $\leq$ 5 mm

KWALITEIT BEVESTIGD

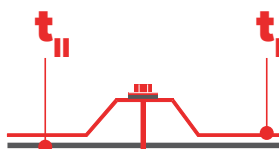
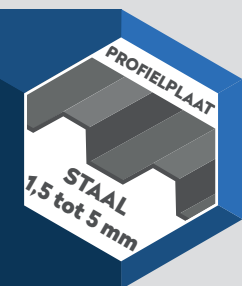

**PROFIELPLATEN - STAAL 1,5 TOT 5 MM - VERZINKT**

		$t_{NI}$ [mm]	$t_{II}$ [mm]					
			0,75	1,00	1,50	2,00	3,00	4,00
 $V_{R,k}$ [kN]	0,40	1,12	1,12	1,12	1,12	1,12	1,12	1,12
	0,50	1,61	1,61	1,61	1,61	1,61	1,61	1,61
	0,55	1,69	1,69	1,69	1,69	1,69	1,69	1,69
	0,63	1,81	1,81	1,81	1,81	1,81	1,81	1,81
	0,75	1,99	1,99	1,99	1,99	1,99	1,99	1,99
	0,88	1,99	3,17	3,17	3,17	3,17	3,17	3,17
	1,00	3,17	3,17	3,17	3,17	3,17	3,17	3,17
	1,13	3,17	3,17	3,17	3,17	3,17	3,17	3,17
	1,25	3,17	3,17	3,17	3,17	3,17	3,17	3,17
 $N_{R,k}$ [kN]	0,40	0,68	0,94	1,81	1,81	1,81	1,81	1,81
	0,50	0,68	0,94	2,06	2,47	2,47	2,47	2,47
	0,55	0,68	0,94	2,06	2,64	2,79	2,79	2,79
	0,63	0,68	0,94	2,06	2,64	3,31	3,31	3,31
	0,75	0,68	0,94	2,06	2,64	4,09	4,09	4,09
	0,88	0,68	0,94	2,06	2,64	4,09	4,09	4,09
	1,00	0,68	0,94	2,06	2,64	4,09	4,09	4,09
	1,13	0,68	0,94	2,06	2,64	4,09	4,09	4,09
	1,25	0,68	0,94	2,06	2,64	4,09	4,09	4,09

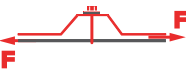
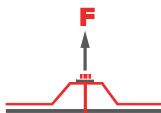
**Toelichting**

1. Bovenstaande waarden zijn karakteristieke waarden
2. Voor het bepalen van de rekenwaarde adviseren wij een materiaalfactor  $\gamma_m = 1,33$  te gebruiken
3. Verdere uitleg en rekenvoorbeelden treft u aan op pagina 10.1.7