

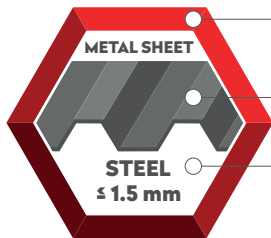

SELF-DRILLING TORX SCREW DP1

APPLICATION



Bi-metal A2 304

Metal sheet Screw

Steel ≤ 1,5 mm

SPECIFICATION

- 1 Head style Torx 25
- 2 Washer SS/EPDM 9 mm
- 3 Thread for substructure steel ≤ 1,5 mm
- 4 Drilling point 1 (hardened steel)

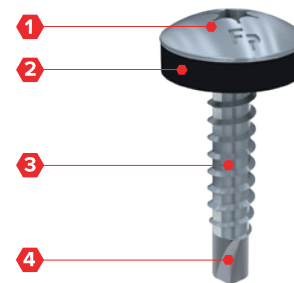

OPTIONS

- 1 Powder coated in any desired RAL colour

SECTION

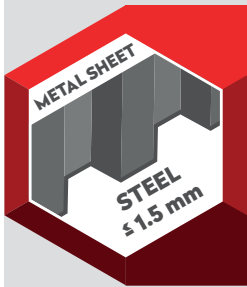
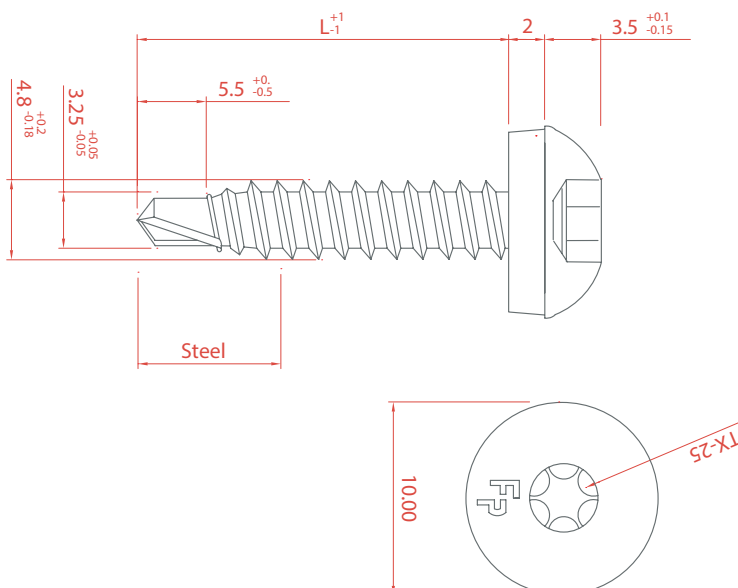

METAL SHEETS - STEEL ≤ 1,5 MM - BI-METAL A2 304

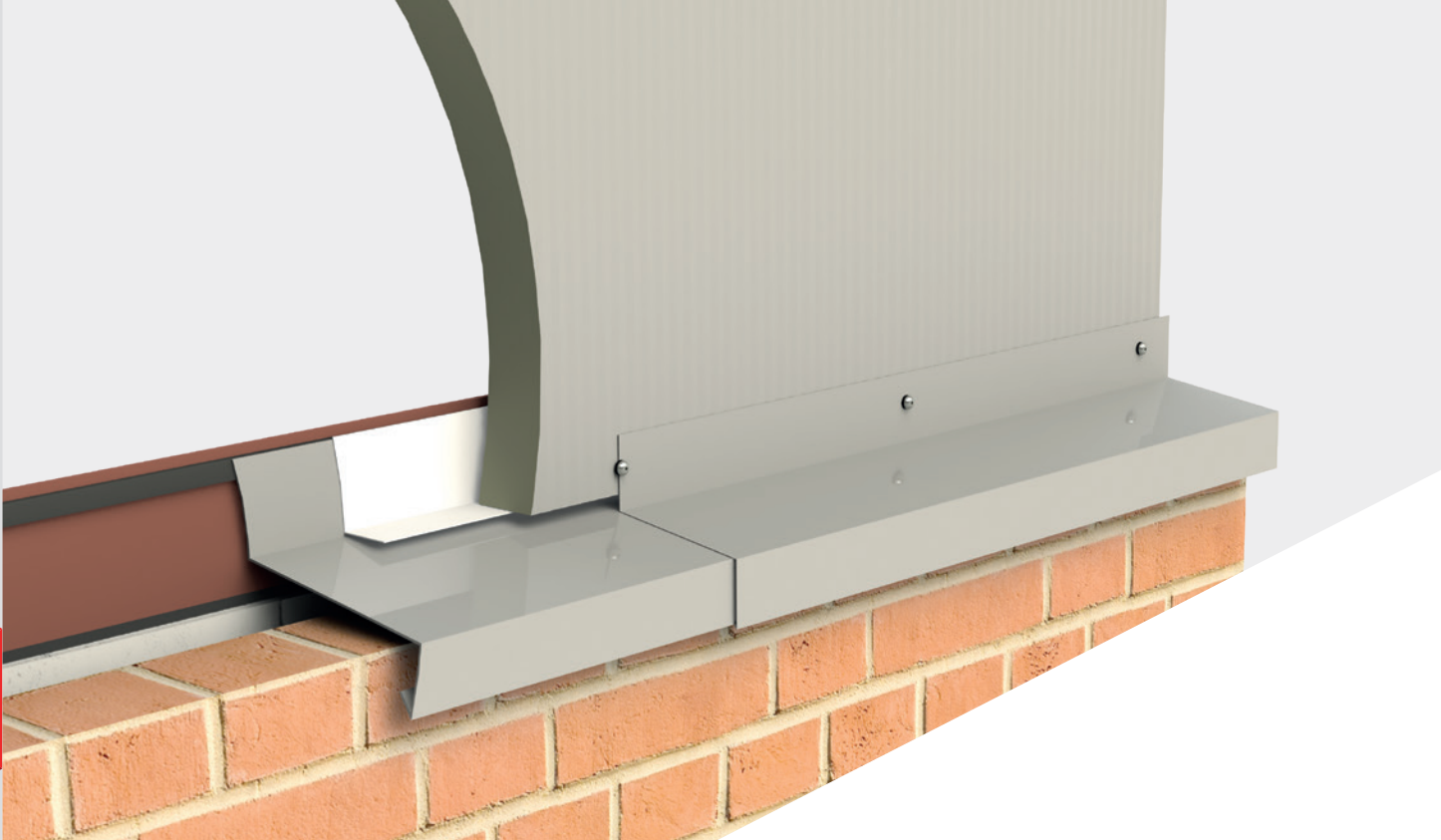
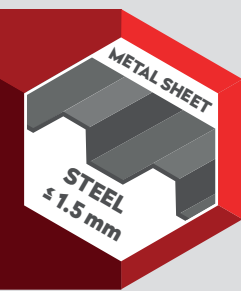

METAL SHEETS - STEEL ≤ 1,5 MM - BI-METAL A2 304

ORDER INFORMATION

Product	Size (L)	Packaging	Article code
Self-Drilling torx Screw 4,8 x 22 - DP1	22 mm	500 pcs/box	20010148022M
Self-Drilling torx Screw 4,8 x 35 - DP1	35 mm	500 pcs/box	20010148035M



More information on materials, application, specific properties and certification can be found in chapter 10.

CERTIFICATES



QUALITY
CONFIRMED

SELF-DRILLING TORX SCREW 4,8 X L - DP1, WASHER DIAMETER Ø 10,0 MM

Materials	
Screw	SS 1.4301 (A2) - conform EN3506
Washer	SS 1.4301 (A2) - conform EN3506
Material A (t_{I})	S280GD, S320GD and S350GD conform EN 10346
Material B (t_{II})	S235 conform EN 10025-2, S280GD, S320GD and S350GD conform EN 10346
Drilling capacity	Steel $\leq 1,5$ mm





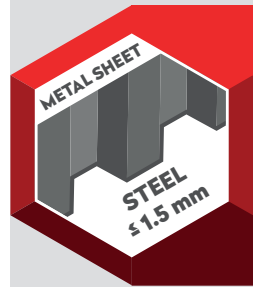
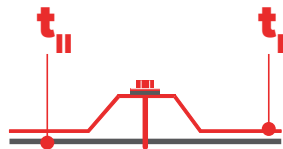

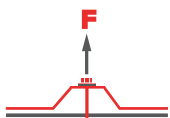
		t_{NI} [mm]	t_{II} [mm]									
			0,40	0,50	0,55	0,63	0,75	0,88	1,00	1,13	1,25	1,50
 $V_{R,k}$ [kN]	0,40	1,01	1,01	1,01	1,01	1,01	1,01	1,01	1,01	1,01	1,01	1,01
	0,50	1,01	1,52	1,52	1,52	1,52	1,52	1,52	1,52	1,52	1,52	1,52
	0,55	1,01	1,52	1,56	1,56	1,56	1,56	1,56	1,56	1,56	1,56	1,56
	0,63	1,01	1,52	1,56	1,63	1,63	1,63	1,63	1,63	1,63	1,63	1,63
	0,75	1,01	1,52	1,56	1,63	1,73	1,73	1,73	1,73	1,73	1,73	1,73
	0,88	1,01	1,52	1,56	1,63	1,73	2,71	2,71	2,71	2,71	2,71	2,71
	1,00	1,01	1,52	1,56	1,63	1,73	2,71	2,71	2,71	2,71	2,71	2,71
	1,13	1,01	1,52	1,56	1,63	1,73	2,71	2,71	2,71	2,71	2,71	2,71
	1,25	1,01	1,52	1,56	1,63	1,73	2,71	2,71	2,71	2,71	2,71	2,71
 $N_{R,k}$ [kN]	0,40	0,39	0,48	0,57	0,72	0,94	1,22	1,22	1,22	1,22	1,22	1,22
	0,50	0,39	0,48	0,57	0,72	0,94	1,35	1,65	1,97	2,00	2,00	2,00
	0,55	0,39	0,48	0,57	0,72	0,94	1,35	1,65	1,97	2,25	2,25	2,25
	0,63	0,39	0,48	0,57	0,72	0,94	1,35	1,65	1,97	2,27	2,64	2,64
	0,75	0,39	0,48	0,57	0,72	0,94	1,35	1,65	1,97	2,27	2,88	3,23
	0,88	0,39	0,48	0,57	0,72	0,94	1,35	1,65	1,97	2,27	2,88	3,99
	1,00	0,39	0,48	0,57	0,72	0,94	1,35	1,65	1,97	2,27	2,88	3,99
	1,13	0,39	0,48	0,57	0,72	0,94	1,35	1,65	1,97	2,27	2,88	3,99
	1,25	0,39	0,48	0,57	0,72	0,94	1,35	1,65	1,97	2,27	2,88	3,99

Note

1. Above mentioned values are characteristic values.
2. To determine the design value we advise to apply a material factor of $\gamma_m = 1,33$.
3. You can find further information and calculation examples on page 10.1.7.

METAL SHEETS - STEEL $\leq 1,5$ MM - BI-METAL A2 304

